



48" FULLY INTEGRATED SIDE-BY-SIDE REFRIGERATOR



DETAILED PLANNING DIMENSIONS GUIDE

(BASE UNIT REQUIRES SUITE-COORDINATING FULL HEIGHT PANEL KIT OR CUSTOM PANELS AND HANDLES)

JS48NXXFXDE – 47¾" (W) x 83½" (H) x 24" (depth without door panels/handles)

BASE UNIT + FULL HEIGHT PANEL KIT = FINISHED REFRIGERATOR

Easily transform these overlay refrigerators into one of our signature kitchen suite designs with one of our suite-coordinating stainless steel panel kits. To do so, you must order one of the overlay base units (left column) and one of the suite-coordinating panel kits. The kits include refrigerator and freezer door panels, air grille and pre-installed handles.

Base Unit Model Number	Coordinating Stainless Full Height Panel Kits			
	RISE™ Stainless		NOIR™ Stainless	
Side-by-Side JS48NXXFXDE	JBSFS48NHL		JBSFS48NHM	

OPTIONAL ACCESSORIES FOR CUSTOM OVERLAY DESIGNS



ARMOIRE-STYLE DOOR PANEL KIT

W10663564 – 42" – Obsidian Interior

- For use with fully integrated and flush refrigerators
- Enables installation and proper venting of full height custom door panels (not included) that hide the top panel
- Includes left and right grille brackets and machine compartment cover

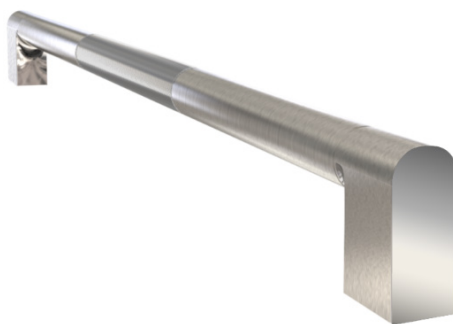

RISE™ STAINLESS HANDLE KIT

W11231243 – 48" Side-by-Side

- For use with Custom Overlay fully integrated built-in refrigerators

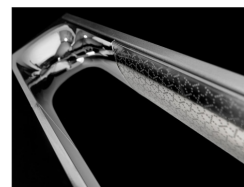

NOIR™ STAINLESS HANDLE KIT

W11194770 – 48" Side-by-Side

- For use with Custom Overlay fully integrated built-in refrigerators

Because Whirlpool Corporation policy includes a continuous commitment to improve our products, we reserve the right to change materials and specifications without notice.

Dimensions are for planning purposes only. For complete details, see Installation Instructions packed with product. Specifications subject to change without notice.



48" FULLY INTEGRATED SIDE-BY-SIDE REFRIGERATOR

DETAILED PLANNING DIMENSIONS GUIDE

(BASE UNIT REQUIRES SUITE-COORDINATING FULL HEIGHT PANEL KIT OR CUSTOM PANELS AND HANDLES)

JS48NFXDE – 47³/₄" (W) x 83¹/₈" (H) x 24" (depth without door panels/handles)

PRODUCT DIMENSIONS (INCLUDING STAINLESS STEEL DOOR PANEL KIT DIMENSIONS)

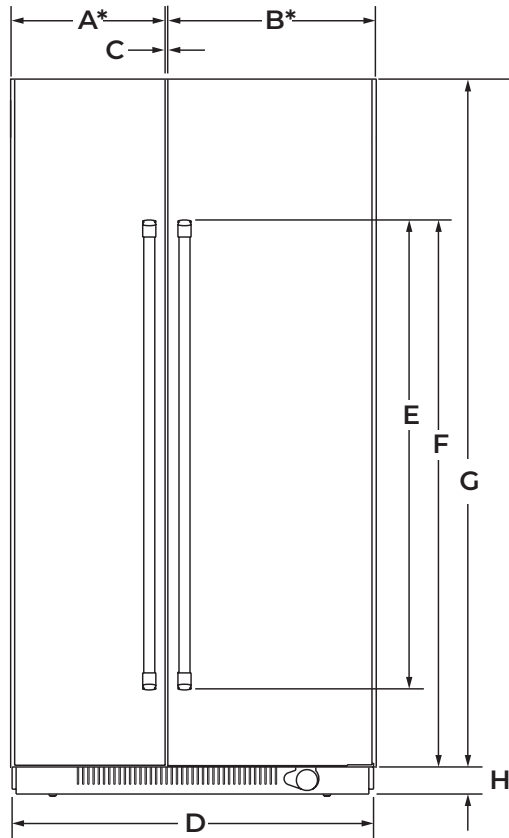

FRONT VIEW

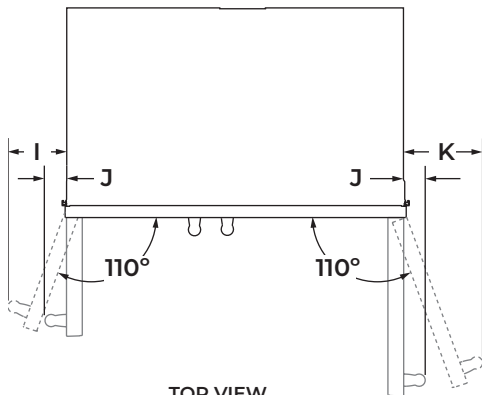

TOP VIEW

DIMENSION	DESCRIPTION	JS48NFXDE
A*	Width of freezer door	20 ⁵ / ₁₆ " (51.6 cm)
B*	Width of refrigerator door	27 ⁵ / ₁₆ " (69.4 cm)
C	Space between doors	1/8" (0.3 cm)
D	Overall width (including vinyl side trim)	47 ³ / ₄ " (121.3 cm)
E	Height of door handle	
	RISE™ Stainless	58" (147.3 cm)
	NOIR™ Stainless	40 ⁵ / ₈ " (103.2 cm)
F	Height to top of door handle	
	RISE™ Stainless	71 ¹ / ₁₆ " (182.1 cm)
	NOIR™ Stainless	69 ¹³ / ₁₆ " (177.3 cm)
G	Height of door	81" (205.7 cm)
H	Height of bottom grille	3" (7.6 cm)
I	Width from side of refrigerator to freezer door handle – door fully open 110°	
	RISE™ Stainless	8 ³ / ₈ " (20.7 cm)
	NOIR™ Stainless	7 ⁵ / ₈ " (19.3 cm)
J	Width from side of refrigerator to handle – door open 90°	
	RISE™ Stainless	2 ³ / ₈ " (6.1 cm)
	NOIR™ Stainless	1 ⁵ / ₈ " (4.1 cm)
K	Width from side of refrigerator to refrigerator door handle – door fully open 110°	
	RISE™ Stainless	10 ⁹ / ₁₆ " (26.8 cm)
	NOIR™ Stainless	10 ¹ / ₁₆ " (25.5 cm)

*Door width dimensions are for stainless steel panel kit only.

Because Whirlpool Corporation policy includes a continuous commitment to improve our products, we reserve the right to change materials and specifications without notice.

Dimensions are for planning purposes only. For complete details, see Installation Instructions packed with product. Specifications subject to change without notice.



48" FULLY INTEGRATED SIDE-BY-SIDE REFRIGERATOR

DETAILED PLANNING DIMENSIONS GUIDE

(BASE UNIT REQUIRES SUITE-COORDINATING FULL HEIGHT PANEL KIT OR CUSTOM PANELS AND HANDLES)

JS48NFXDE – 47³/₄" (W) x 83¹/₈" (H) x 24" (depth without door panels/handles)

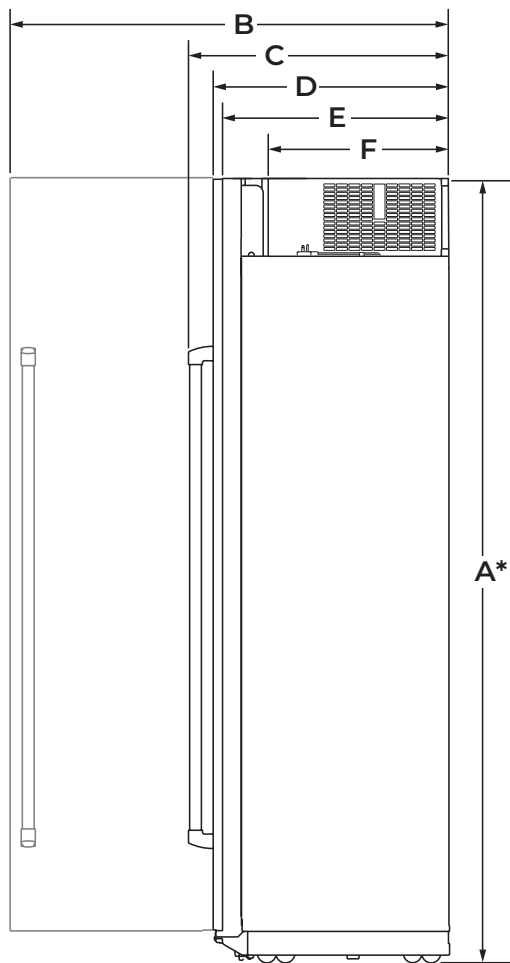

SIDE VIEW

DIMENSION	DESCRIPTION	JS48NFXDE
A*	Height of recessed refrigerator (min.)	83 ¹ / ₈ " (211.1 cm)
B	Depth with refrigerator door open 90° (min.)	50 ³ / ₄ " (128.8 cm)
C	Depth with handles (min.)	
	RISE™ Stainless	27 ¹ / ₁₆ " (70.2 cm)
	NOIR™ Stainless	26 ⁷ / ₈ " (68.2 cm)
D	Depth with doors (min.)	
	RISE™ Stainless	24 ³ / ₄ " (62.8 cm)
	NOIR™ Stainless	24 ³ / ₄ " (62.8 cm)
	Custom panel (3/4"/1.9 cm)	24 ³ / ₄ " (62.8 cm)
E	Depth without door panel kit (min.)	24" (61 cm)
F	Depth of compressor cover (min.)	19 ⁷ / ₈ " (50.5 cm)

*Add 1¹/₄" (3.2 cm) to the height dimension when leveling legs are fully extended.



48" FULLY INTEGRATED SIDE-BY-SIDE REFRIGERATOR

DETAILED PLANNING DIMENSIONS GUIDE

(BASE UNIT REQUIRES SUITE-COORDINATING FULL HEIGHT PANEL KIT OR CUSTOM PANELS AND HANDLES)

JS48NFXDE – 47³/₄" (W) x 83¹/₈" (H) x 24" (depth without door panels/handles)

AIRFLOW VENTING RECOMMENDATIONS

ARMOIRE-STYLE/FULL HEIGHT DOOR PANEL KIT INSTALLATION

IMPORTANT :

- Armoire-style/Full height door panel kit installations recommend a minimum of 1/8" (3.2 mm) of open space above the refrigerator. It is recommended that this space not be blocked in any way, including soffits.
- Models may be installed using either Option 1, Option 2 or Option 3.

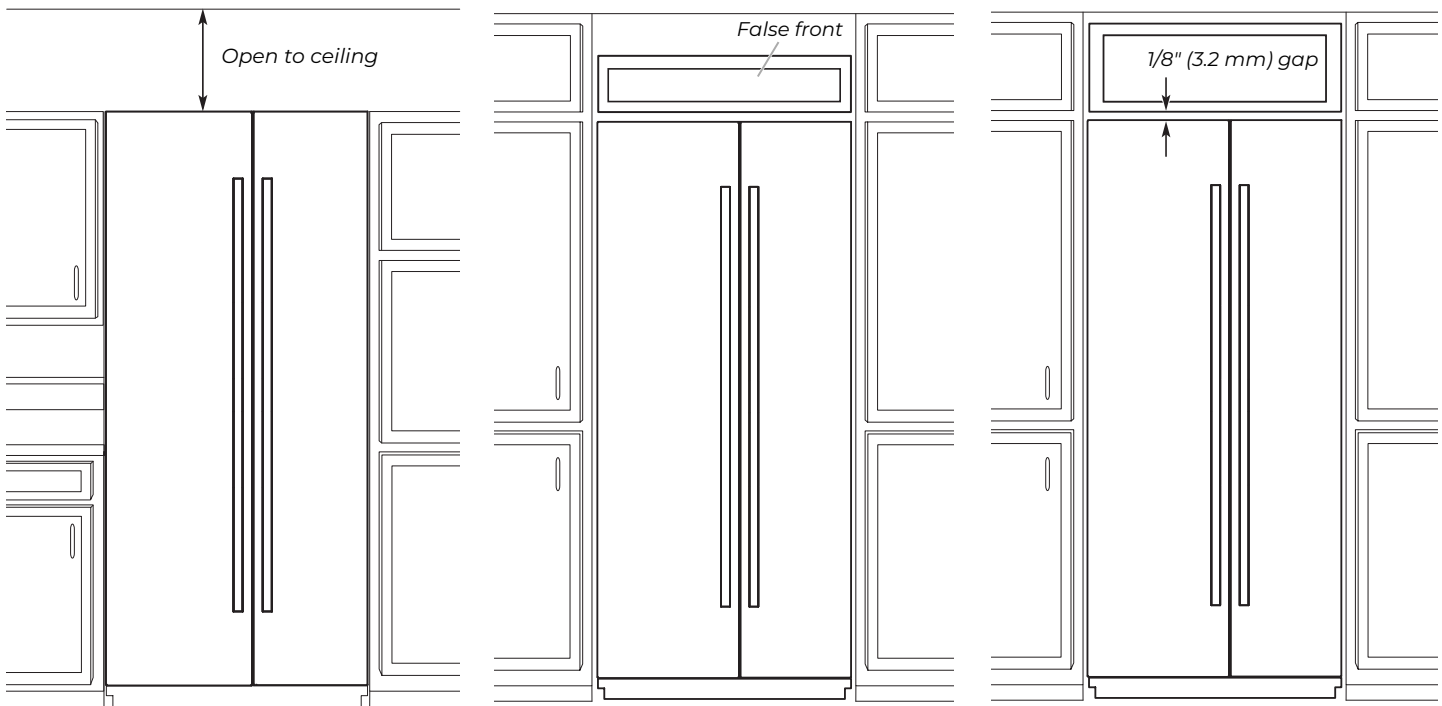

Option 1 - Open to Ceiling

Option 2 - False Front
(cabinet face only)

Option 3 - Closed Soffit

Because Whirlpool Corporation policy includes a continuous commitment to improve our products, we reserve the right to change materials and specifications without notice.

Dimensions are for planning purposes only. For complete details, see Installation Instructions packed with product. Specifications subject to change without notice.



48" FULLY INTEGRATED SIDE-BY-SIDE REFRIGERATOR

DETAILED PLANNING DIMENSIONS GUIDE

(BASE UNIT REQUIRES SUITE-COORDINATING FULL HEIGHT PANEL KIT OR CUSTOM PANELS AND HANDLES)

JS48NFXDE – 47³/₄" (W) x 83¹/₈" (H) x 24" (depth without door panels/handles)

OPENING/CLEARANCE DIMENSIONS

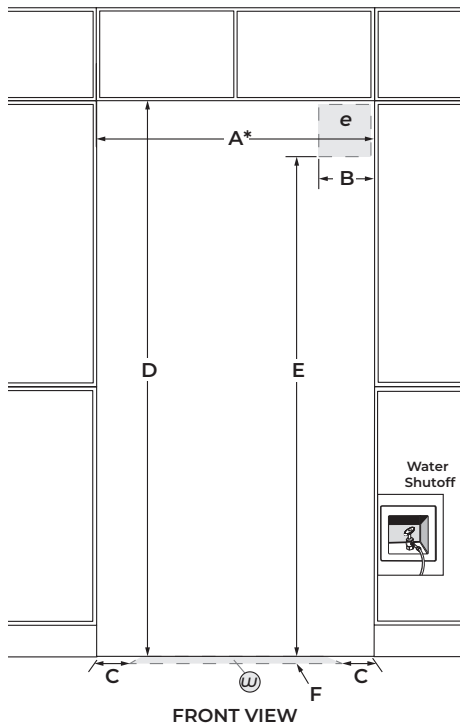

FRONT VIEW

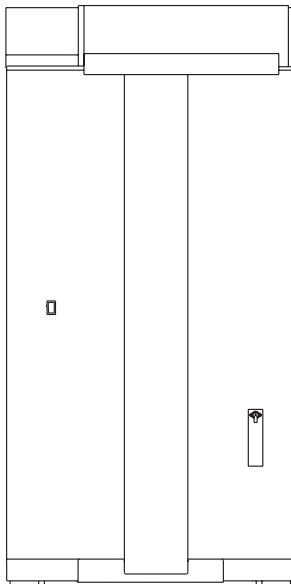

BACK VIEW

DIMENSION	DESCRIPTION	JS48NFXDE
A*	Width (min.)	48" (106.7 cm)
B	Width of recommended electrical location	13 ¹ / ₂ " (34.3 cm)
C	Distance from side of cabinet to recommended water connection location	6" (15.2 cm)
D	Height (min.)	84" (213.4 cm)
E	Height to recommended electrical location	77" (195.6 cm)
F	Depth of recommended water connection location (max.)	1" (2.5 cm)
e	Recommended electrical connection location	
w	Recommended water connection location	

*A minimum 2" (5.1 cm) furniture return must extend behind the face of the cabinet on all sides.

Because Whirlpool Corporation policy includes a continuous commitment to improve our products, we reserve the right to change materials and specifications without notice.

Dimensions are for planning purposes only. For complete details, see Installation Instructions packed with product. Specifications subject to change without notice.

ELECTRICAL REQUIREMENTS

⚠ WARNING



Electrical Shock Hazard

Plug into a grounded 3 prong outlet.

Do not remove ground prong.

Do not use an adapter.

Do not use an extension cord.

Failure to follow these instructions can result in death, fire, or electrical shock.

115 V, 60 Hz, AC only, 15 or 20 A fused, grounded circuit is required. A dedicated circuit is recommended. Use an outlet that cannot be turned off by a switch. Do not use an extension cord.

WATER PRESSURE REQUIREMENTS

A cold water supply with water pressure between 30 and 120 psi (207 and 827 kPa) is required to operate the ice maker. Call a licensed, qualified plumber with any questions about the water pressure.

Reverse Osmosis Water Supply

IMPORTANT: The pressure of the water coming out of a reverse osmosis system going to the water inlet valve of the refrigerator needs to be between 30 and 120 psi (207 and 827 kPa).

If a reverse osmosis water filtration system is connected to the cold water supply, the water pressure to the reverse osmosis system needs to be a minimum of 40 to 60 psi (276 to 414 kPa).

LOCATION REQUIREMENTS

Floor must be able to support refrigerator (more than 600 lb [272 kg]), door panels and contents of the refrigerator and must be at the same level as flooring in the room.